

# Data Sheet

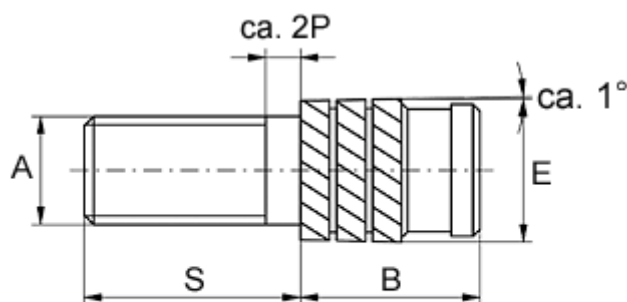

Article number: 12856000020880  
Description: KLEE-coil 856 000 020.880  
M2 Brass

## Measures



Gevindlængde =  $S - 2P$   
P = stigning

Male thread A	= M2x0,4
Min distance to edge	= 1.6
Mounting length B	= 4.0
Outer diameter E	= 3.35
Pin length S	= 25
Recommended bore diameter	= 3.1
Type	= 856 000 020.880